

USER MANUAL
Published May 2014
Software Version 8.80



ZAXCOM.COM

TRXLA2

The Standard In Sound Evolved

KNOWING YOUR TRXLA2.....	4
HOME SCREEN EXPLAINED	6
MAIN MENU	7
NAVIGATING THE MAIN MENU	7
EXITING THE MAIN MENU.....	7
AUDIO GAIN SET	7
UHF TRANSMIT FREQUENCY SET	7
TRANSPORT CONTROL	7
TIME CODE FRAME RATE SET.....	8
TIME LEFT ON CARD.....	8
TRANSMITTER LOCK PAGE	8
EXTENDED MENU.....	9
ENTERING AND NAVIGATING THE EXTENDED MENU	9
EXITING THE EXTENDED MENU.....	9
HIGH PASS FILTER ADJUST.....	9
2K NOTCH FILTER ENABLE.....	9
UHF TRANSMIT FORMAT SET	10
UHF TRANSMITTER POWER LEVEL SET	10
POWER ROLL MODE	10
IFB MODE	11
IFB VOTING ENABLE	11
IFB RECEIVE DURATION BEFORE ZAXNET TRANSMISSION BEGINS	12
ZAXNET IFB RECEIVE FREQUENCY SET	12
ZAXNET IFB TRANSMIT FREQUENCY SET	13
IFB RECEIVE PULSE	13
IFB TRANSMIT POWER SET.....	13
IFB RECORD TONE.....	14
POWER-UP MODE.....	14
SD CARD FORMAT	14
TIME CODE JAM MODE SELECT	15
TIME CODE SOURCE SELECT.....	15
MUTE TIME CODE TRANSMISSION UNTIL JAMMED	15
GROUP ID SET	16
UNIT ID SET	16
DYNAMICS	17
BATTERY TYPE SET	18
RECORDING MODE SET.....	18
BOOT UP POWER MODE SELECT	18
LEFT RIGHT SWITCH	19
ALLOW IFB REMOTE CONTROL	19
IFB JAM THRESHOLD.....	19
QRX SOFTWARE UPDATE.....	20
PHASE INVERT CHANNEL 2	20
TRANSMITTER DISABLE - RECORD ONLY MODE.....	20
LOW BATTERY STOP SET	21
AUTOMATIC RECORD AFTER BOOTUP	21
TRANSMITTER NAME SET	21
ENCRYPTION MENU HIDE.....	22
ENCRYPTION CODE SET.....	22

MEDIA23
 MEDIA CAPACITY.....23
 RECORDING FORMAT23

FIRMWARE24
 UPDATING TRX FIRMWARE24
 UPDATING AN ERX WITH YOUR TRX TRANSMITTER.....25

INPUTTING AUDIO26

RECOMMENDED MICROPHONES26

WIRING DIAGRAMS.....26
 TWO WIRE MICROPHONE CONFIGURATION.....26
 THREE WIRE MICROPHONE CONFIGURATION.....26
 STEREO MICROPHONE CONFIGURATION.....27
 BALANCED LINE LEVEL AND TIME CODE INPUT27
 STEREO LINE LEVEL27

OPERATING FREQUENCIES.....28
 ZAXNET REMOTE CONTROL AND TIME CODE28
 UHF AUDIO28

SPECIFICATIONS.....30

PRODUCT SUPPORT31
 CONSUMER ALERT31

ZAXCOM WARRANTY POLICY AND LIMITATIONS.....32

Knowing your TRXLA2

The TRXLA2S is a stereo version of the TRXLA2 transmitter. The LA2S stereo transmitter can take two lavalier microphones via the single 3-pin LEMO connector and transmit both sources over one frequency. The TRXLA2S stereo transmitter can also be set to operate in mono mode- while the LA2 transmitter cannot.



1. SSMA Antenna Connector
2. LCD Display
3. Card Key
4. Microphone Input Connector (3 Pin Lemo)
5. INC / Record Key
 - Increases the parameters of a menu item.
 - When in the Home Screen pressing **INC** with the **CARD** key will put the TRX into record.
 - When in the Transport Control Screen while not recording will cause the TRX to play back.
 - Press it while playing back to fast forward.
 - Press and hold while in the Transport Control Screen to advance to the next segment.
 - Press it in the Home Screen to display the current segment number.
6. DEC / Stop Key
 - Decreases the parameters of the menu items.
 - When in the Home Screen pressing **DEC** with the **CARD** key will stop the recording.
 - When playing back from the Transport Control Screen will cause the TRX to stop.
 - Press and hold while in the Transport Control Screen will jump back to the previous segment.
 - Holding it while playing back will take you to the start of that segment.
 - Pressing it in the Home Screen will display the battery voltage.
7. Menu / Play Key
 - Press it to access the next menu.
 - Pressing it while powering up will take you into the Extended Menu.
 - Press it with the Card Key to Playback a segment.

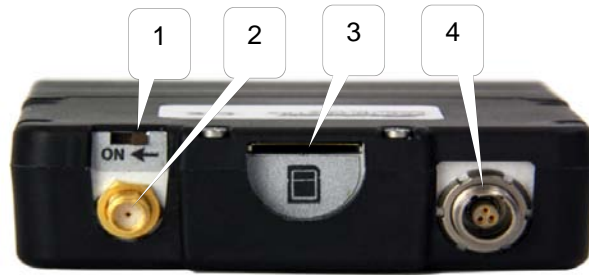

1. Power Switch
2. SSMA Antenna Connection
3. Media Slot Media Slot

To insert a Micro SD card, with the screen of the transmitter facing you, turn the card so the finger contacts are facing you and pointing down toward the slot. Insert the card into the slot and press it down until you here a slight click. To remove it, press the card in until you hear the same click again.

4. Microphone / Input connector (3 pin Lemo)



5. Battery Compartment

TRXLA2 will use 2 AA batteries. You can use alkaline, Lithium or NiMH batteries.

Home Screen Explained

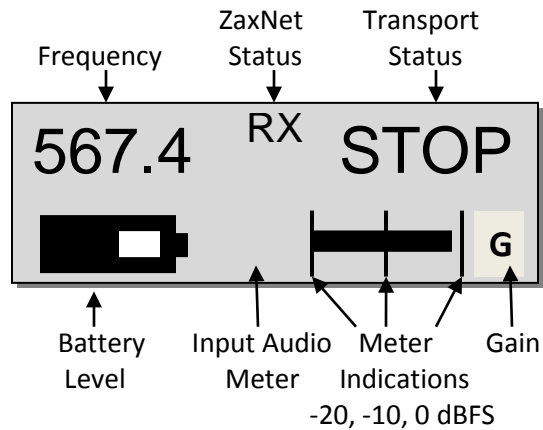

Frequency

This is the transmit frequency of the TRXLA2.

If the transmitter is being used in RECORD ONLY mode "NOTX" will be displayed.

ZaxNet Status

- RX – The transmitter is set to receive ZaxNet time code and commands.
- TX – The transmitter is sending ZaxNet time code and audio.

Transport Status - Displays the current mode of the recording feature.

- STOP – Recording / Playback is stopped
- LREC – TRX is recording and LOOP RECORD mode is enabled
- REC – TRX is recording and NON-LOOP RECORD mode is enabled
- WAIT – May appear just before going into record, or if the card is ejected while recording.

Input Audio Meter- Displays the modulation of the inputted audio signal.

In the case of a TRXLA2 if the transmitter is set to STEREO mode you would see both the left and right audio levels.

Gain - "G" Appears when the transmitter is receiving change of gain commands via ZaxNet.

When in the home screen:

- Press and hold the INC key to display the number of record segments are on the card. Note that regardless of the size of the card it is limited to 256 segments.
- Press and hold the DEC key to display the current battery voltage

Main Menu

Navigating the Main Menu

- Press the MENU key to enter the menu.
- To advance to the next menu press the MENU key again.

Exiting the Main Menu

- To exit the menu at any time press and hold the MENU key for 1.5 seconds

Audio Gain Set



This menu is where the gain of the incoming audio is set. The meter indicates the audio signal displayed horizontally from left to right. The TRXLA2S set to stereo mode will display two meters - one for each channel. The gain in stereo mode is applied to both sources.

UHF Transmit Frequency Set

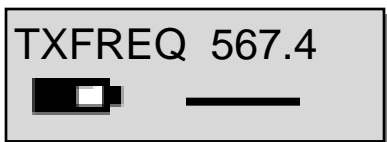

This menu is where the UHF transmit frequency set.

- Short presses of the INC or DEC key causes the value to change by 0.1 MHz
- Holding the INC or DEC key causes the value to change by 0.5 MHz

Transport Control

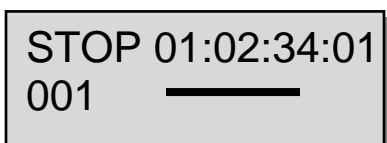

This page displays the transport status and allows playback.

The top line displays the current mode: REC, PLAY or STOP followed by the time code.

The bottom line contains the current segment number and the audio level.

Playing back from the transport page:

- Pressing the INC key while stopped will play the segment that is displayed.
- Pressing the INC key while in play mode will fast forward.
- Pressing the DEC key while playing back will stop the playback.
- Holding the DEC key while playing back will take you to the start of that segment.
- Pressing the DEC key while stopped will rewind.

Time Code Frame Rate Set

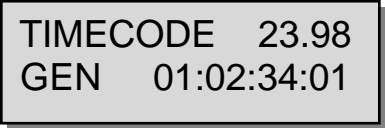

TIMECODE 23.98
GEN 01:02:34:01

This menu is where the time code frame rate is set.

The TRXLA2 will lock to and record all standard time code frame rates.

- 23.98, 24, 25, 29.97DF, 29.97DF, 30 DF, 30 NDF

Time Left on Card



TIME LEFT 20H
TIME USED 4H

This page displays the remaining time left on the card and the time already recorded on the card.

This page will not be displayed if no card is present.

Transmitter Lock Page

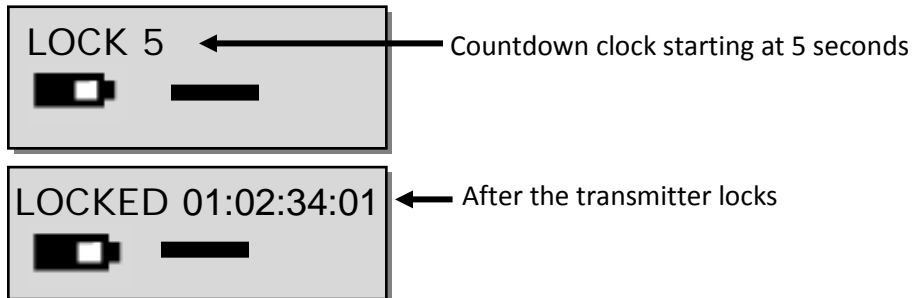

This page enables a lock function to prevent any accidental changes.

When you land on this page the countdown clock will begin. After 5 seconds the transmitter will lock and the display will indicated LOCKED.

If you exit this screen before the 5 seconds is up the transmitter will not lock.

Even though the key's will be locked you can press the INC or DEC key to temporarily display the current battery voltage in place of the battery icon.

To Unlock

- Simultaneously press the MENU and INC keys.
Or
- Powering down the unit will clear the lock.

Extended Menu

Entering and Navigating the Extended Menu

- Press and hold the MENU key while powering up the unit.
- Pressing the MENU key will advance you to the next menu item.

Exiting the Extended Menu

- Cycle the power
Or
- Hold down the MENU key to get back to the EXTENDED MENU home page then press the INC key.

High Pass Filter Adjust



HIGH PASS: OFF

Turn on and adjusts the frequency of the high pass filter from this page.

- The high pass filter range is **30Hz** to **220Hz** in **10Hz** increments.

2K Notch Filter Enable

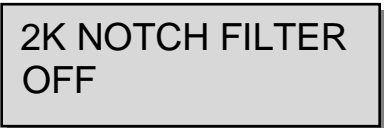

2K NOTCH FILTER
OFF

Enable/disable the 2K notch filter from this page.

The 2K notch filter is useful in removing digital RF interference that can be introduced into the microphone.

UHF Transmit Format Set

**TX FORMAT:
XR MONO**

Adjust the UHF transmission format from this page

- **XR (MONO)** -This format uses enhanced modulation for better range and less dropouts - and is the recommended setting.
XR will be used with the **NORMAL** setting on the QRX and is not compatible with the RX900.
- **US MONO** - This format is used for mono transmission.
US MONO will be used with **0=US** setting on the RX900 receiver or **NORMAL** on the QRX
- **STEREO** -This format is used for stereo transmission of a TRX-LAS2
Stereo will be used with **2=ST** setting on the RX900 receiver or **NORMAL** on the QRX.
- **EUROPEAN** -This format is for use in countries where a normal width channel is NOT legal.
European will be used with **1=EU** setting on the RX900 receiver or **NARROW** on the QRX.
- **US MONO-R** -Similar to **US MONO**. This can be used to force mono audio to the right channel.
US MONO-R will be used with **0=US** setting on the RX900 receiver.

IMPORTANT: Any change to this page REQUIRES a reboot before the new setting takes effect.

IMPORTANT: If the transmission format set here and the reception format on the associated receiver do not match, the receiver will be unable to correctly decode the audio from this transmitter.

UHF Transmitter Power Level Set

TX POWER: 125 MW

Adjust the UHF transmit power of the transmitter from this page.

- The TRXLA2 can be set at **25, 50** or **125mW**

Power Roll Mode

**POWER ROLL:
OFF**

Adjust the Power Roll setting of the TRXLA2 from this page.

Power Roll will allow the transmitter to stay in a lower transmit power setting to conserve battery power, then when you begin to record the transmitter will increase the transmit power.

- **OFF** – Power roll is disabled.
- **DIVA TRIGGER** – A command from a Zaxcom recorder will set the transmitter to full power.
- **RECORD TRIGGER** – When the transmitter goes into record either manually or from an AUTO-LOAD trigger the TRXLA2 will go to full power.

IFB Mode

IFB MODE: TX

In this menu you will set the mode of the ZaxNet transmitter.

- **OFF** - The ZaxNet transmitter is disabled. The TRX will not receive ZaxNet commands / time code and it will not send any ZaxNet audio.
If this is set to OFF the next 5 ZaxNet menu items will not appear.
- **RX** - The transmitter will receive ZaxNet commands and time code.
- **TX** - The transmitter will send ZaxNet confidence audio.

NOTE: If the **IFB RX to TX** setting is set anything other than **Normal** you will not be allowed to set the IFB mode to OFF.

IFB Voting Enable

This menu will not appear if the IFB settings allow the TRX to go into transmit mode.

IFB VOTING NORMAL (OFF)

This menu allows you to enable / disable the IFB Voting function.

The purpose of IFB voting is to allow the TRXLA2 to choose and switch to the stronger signal from two different ZaxNet transmitters. One purpose of this is if you are on a large set you can place a second IFB transmitter at a different location and the TRXLA2 will choose the stronger signal. Just set the second IFB transmitting frequency to exactly 2MHz higher than the first unit.

NOTE: This page only will appear if you have the **IFB RX TO TX** mode set to **NORMAL RX** and **RX MODE** is not set to **OFF**. Meaning that if the TRXLA2 IFB will ever be in a transmit mode - IFB voting no longer will be available.

IFB Receive Duration Before ZaxNet Transmission Begins

IFB RX TO TX:
NORMAL RX

← The TRX will receive ZaxNet only and **NOT** go into transmit mode. Therefore no ZaxNet TC and audio will be transmitted.

IFB RX TO TX:
0 SECS: TX ONLY

← The TRX will **ONLY** transmit ZaxNet TC and audio only and will **NOT** receive wireless TC or ZaxNet commands. Essentially shutting off the ZaxNet transmitter.

IFB RX TO TX:
20 SECS

← Adjustable from 1 up to 20 Seconds. After boot up the TRX will search for a ZaxNet signal for XX seconds before it begins to transmit ZaxNet TC and confidence audio.

This menu adjusts how long after power up that the TRXLA2 will search for ZaxNet time code before it begins transmitting IFB audio for monitoring purposes. This is necessary if you want your transmitter to lock to ZaxNet time code before you use your ZaxNet transmitter to send confidence audio.

IMPORTANT: After changing this setting a re-boot is required.

ZaxNet IFB Receive Frequency Set

RXFREQ: 2.403

RXFREQ: 2.403 RX
SIGNAL: 28

When the TRX is receiving a ZaxNet signal you will also see:
 ← ZaxNet receive frequency and RX shows that ZaxNet is being received
 ← Signal strength meter
 ← Signal strength

This is where you set the ZaxNet receive frequency.

- This is the frequency that the transmitter will receive wireless ZaxNet TC and commands from - as long as this frequency matches the frequency of the corresponding ZaxNet transmitter - which can be a QRX, Nomad, TRX900CL or IFB100/200.
- This frequency is the frequency that the transmitter will receive TC from another TRX transmitter or a ZFR recorder as long as this frequency matches the frequency of the corresponding transmitter.

ZaxNet IFB Transmit Frequency Set

IFB TX FREQ:
2.420

This is where you set the ZaxNet transmit frequency. This is the frequency that the transmitter will broadcast time code and ZaxNet audio on for the purpose of confidence audio monitoring via an ERX receiver or Nomad. Note this is just for quality control purposes and the expected range will be less than 30 feet.

IFB Receive Pulse

This menu will only appear if IFB is set to go into transmit mode.

IFB RX PULSE:
NEVER

← The TRX will stay in transmit mode and never go into receive mode.

IFB RX PULSE:
600 SECS

← The TRX will go out of transmit mode every 10 minutes
Note: You would need to use this setting if you are monitoring audio via an ERX receiver and you still want the transmitter to update TC.

This is where you set how often the transmitter will search for time code while sending ZaxNet confidence audio.

When enabled this tells the TRXLA2 to leave ZaxNet transmit mode once every XXX seconds to go into receive mode so it can re-jam its time code wirelessly via ZaxNet. This has no effect on the UHF audio transmission.

You would use this when you are using ZaxNet on the TRXLA2 for confidence monitoring and you still want the transmitter to update time code at set intervals.

- The settings are **NEVER** or any interval between **10** and **999** seconds.

NOTE: When searches for TC ZaxNet will temporarily go out of transmit mode for approximately 1 second as it receives a TC signal. UHF audio is unaffected.

IFB Transmit Power Set

IFB TX POWER: 7

This menu sets the power level of the ZaxNet transmitter.

- The settings are any interval between **0** and **7** with **7** being the highest.

IFB Record Tone

IFB RECORD BEEP:
OFF

If set to ON, when the TRX is recording, the audio sent to the ERX via ZaxNet will beep in 20 second intervals giving you audible conformation that the TRXLA2 is recording. The beeps will only be heard in the ERX and will not be recorded on the transmitter's card nor will be sent to the receiver.

Power-Up Mode

POWER UP MODE:
LOCKED

This menu determines if the keys will lock after power-up so they can't be accidentally changed.

- **LOCKED** – After power-up has completed, the transmitter will automatically go into Lock Mode and the keys will be locked to prevent accidental changes to the settings.
- **UNLOCKED** – The keys are unlocked upon power-up. You can always lock the keys by going in to the Lock Screen in the Main Menu.

To unlock the keys simultaneously press the MENU and INC keys.

SD Card Format

This menu will only appear if a card is present and was inserted prior to booting up

PRESS UP KEY 5X
TO ERASE CARD

This menu will allow you to erase and format the micro SD card.

IMPORTANT: Even though many cards are sold preformatted, you must format the card in the transmitter prior to recording. Only cards formatted in the TRX will work properly.

To Format a Card:

1. Before formatting the card, you may want to name the transmitter. Naming the card makes it easier to differentiate files from different recorders - for example you can name the card with the talents name. The name menu is located at the end of the Extended Menu (page 21 of this manual).
2. With the power 'OFF', insert the memory card into the media slot with the label to the back of the unit. Press it all the way in till it "clicks".
3. Power up the transmitter while holding the Menu Key to enter the Extended Menu.
4. Advance to this menu.
5. Press the INC key 5 times.
6. You will see "FORMATTING FAT 32"
7. The TRX will displays "SUCCESS" or "FORMAT FAILED ERROR"
8. If "SUCCESS" appears power cycle the TRX and make sure that the unit will record.
9. If you see "FORMAT FAILED ERROR" try to re-format the card and if it fails again **DO NOT** use that card in the transmitter.

Time Code Jam Mode Select

TC JAM MODE:
AUTO-JAM NORMAL

If you are using record run time code this menu controls weather the TRXLA2 will go into record when it receives running time code.

- **AUTO-JAM NORMAL**– The TRX will continuously jam time code via ZaxNet.
- **AUTO-LOAD REC RUN** – The TRX will continuously jam time code via ZaxNet and will start and stop the recording if the unit is receiving record run time code.

In this mode the transmitter will go into record mode when it detects rolling time code. And the will stop when the time code stops. If time code is lost because the IFB signal is too weak the unit will not stop but will continue in whatever state it was in until the time code signal is restored.

Time Code Source Select

TC SOURCE:
IFB (RF)

This menu selects how the TRXLA2 will receive its time code.

- **IFB (RF)** – The transmitter will receive time code via ZaxNet being broadcast from Nomad, a QRX, IFB100/200, TRX900CL, another TRX transmitter or a ZFR recorder. When the transmitter is receiving and locks to a ZaxNet time code signal the word JAM will appear on the home screen.
- **AUDIO INPUT**– The transmitter, with a proper cable, will receive time code via the microphone input. When time code is connected, it takes the transmitter approximately three seconds to recognize the TC. The screen displays TIME CODE followed by JAM when it is recognized. When the word JAM disappears, the time code input source can be disconnected and normal operation can be resumed.

NOTE: When using the microphone input connector, the audio level of the time code signal needs to be between -30 and -10 dBFS on the unit's meter. Any level above -10 may cause clipping, which will prevent proper reading of time code.

Mute Time Code Transmission Until Jammed

MUTE TC UNTIL
JAMMED: OFF

If set to ON the TRXLA2 will not broadcast time code over ZaxNet until it receives and jams its internal time code generator. This prevents the transmitter from sending incorrect time code to another devise.

Group ID Set

REMOTE CONTROL
GROUP ID = 1

This allows you to set your TRXLA2 to a "GROUP" that will be controlled via ZaxNet.

So for example a TRX set to Group 1 will be controlled by a ZaxNet transmitter set to Group 1 and a Group 2 TRX will be controlled by a Group 2 ZaxNet transmitter. This allows a group of receivers to be controlled without affecting others. This will also help if two or more people on set are sending ZaxNet commands each person will be independent and won't interfere with each other. Most users leave this set to 1 on all of their Zaxcom products.

Group codes can be set from **1** to **99**

Unit ID Set

REMOTE CONTROL
UNIT CODE=ALL

This assigns a unique number identify the TRXLA2 within a particular group. This allows individual transmitters in the same group to be independently controlled.

You can set this to **ALL** or assign a number from **1** to **200**

Dynamics

DYNAMICS

The Dynamics is a soft knee compressor that is located after the analog to digital converter. The Dynamics will limit the dynamic range to prevent clipping during occurrences of loud audio. Dynamics is comprised of both a compressor and an expander, which operate jointly. The Compressor in dynamics can set to mild or extreme compression and features a soft knee for more transparent operation.

To enter the Dynamics Menu

Press the INC or DEC key - "PARAMS" (parameters) will be displayed on the right.

To move to the next parameter, press the MENU key.

To exit this page, hold the MENU key for 1 second.

Dynamics Parameters

- **Link L-R: OFF / ON:** This links the left and right if you are using a stereo transmitter. So if one side of the signal needs compressing / expansion the other side will do the same to match.
- **SPEED (Decay Speed) : SLOWEST / SLOW / NORMAL / FAST / FASTEST**
Sets how gradual the signal level decreases after a signal reaches the threshold setting. This is typically set to **FAST**.
- **ATTACK (Attack Speed) : SLOWEST / SLOW / NORMAL / FAST / FASTEST**
Sets the speed in how fast the gain is reduced once the signal exceeds the threshold setting. This is typically set to **FAST**.
- **CMP RATIO (Compressor Ratio):** Valid range: **1.0:** to **5.0:1**, In **0.1** steps.
The amount of gain reduction is determined by the **ratio** setting.
A compressor ratio for example of 2.0:1 means for every 1 dB above the compressor threshold the gain will be reduced 2 dB. A higher ratio setting makes the compressor more aggressive.
- **CMP THRESH (Compressor Threshold):** Valid range: **0** to **-96dB**, in **1dB** steps.
This sets the level of audio in which gain reduction occurs.
- **CMP KNEE: (Compressor Soft Knee):** Valid range: **0** to **20dB**, In **1dB** steps.
This sets the compressor's soft knee. A soft knee reduces "softens" the audible change from uncompressed to compressed, especially for higher ratios where the changeover is more noticeable
- **EXP RATIO (Expansion Ratio):** Valid range: **1:1.00** to **1:4.00**, In **0.01** steps
This sets the expansion ratio. For example a 1:2.0 expansion ratio means for every 1 dB below the expansion threshold the gain will be reduced 2 dB.
- **EXP THRESH (Expansion Threshold):** Valid range: **0** to **-96dB**, in **1dB** steps.
Sets the threshold above which gain reduction occurs.
- **REDUCE (Expander Gain Reduction):** Valid range: **0** to **-36dB**, in **1dB** steps.
This sets the limit on the amount of gain reduction caused by the expander.
- **GAIN (Make-up Gain):** Valid range: **0** to **30dB**, In **1dB** steps.
This is used to compensate for the gain reduction caused by the action of the compressor. Because the compressor is reducing the gain (or level) of the signal, the ability to add a fixed amount of make-up gain at the output is provided so that an optimum level can be used.

Battery Type Set

BATTERY TYPE:
 NIMH

This menu is where the battery type you are using is set. This is so the receiver can properly display the remaining battery capacity.

- The settings are NIMH, Lithium and Alkaline (Displayed as “ - - - -”)

NOTE: In the menu you will see “ENG” and “QRX” options for these battery types as well. This is so each type Zaxcom receiver model (“ENG” RX-900 or “QRX” QRX) can correctly display the transmitter’s battery level.

Recording Mode Set

RECORD MODE:
LOOP RECORD

Record mode adjusts what the transmitter will do after you reach the record capacity of the card.

- **NON-LOOP RECORD** (recommended setting) - Once the card has filled up, recording will stop and FULL will be displayed. This prevents over-writing any portion of the audio.
- **LOOP RECORD** - Once the media has filled up, the new audio will begin over-writing the oldest audio on the card.

Boot Up Power Mode Select

BOOT UP IN
NORMAL MODE

- **REMOTE STANDBY** – The transmitter boots up in Low Power Standby mode. The TRXLA2 will be waiting for a ZaxNet “WAKE” command to come up to full power.
- **STANDBY MODE** – The transmitter boots up in Low Power Standby mode. The TRXLA2 will be waiting for you to press Menu to come up to full power.
- **NORMAL MODE** – The transmitter will boot up in Normal mode.

Left Right Switch

LR SWITCH MODE
OFF

This menu turns on the left / right switch mode.

This function allows the wireless user to cause the audio to switch from the left output to the right output of a stereo RX900 receiver when the key is pressed.

You can select the **UP**, **DOWN**, or **MENU** key to act as the trigger.

NOTE: This is only compatible with the RX900S Receiver

Allow IFB Remote Control

This menu will not appear if the IFB settings allow the TRX to go into transmit mode.

ALLOW IFB REMOTE
CONTROL: ON

If this is set to "ON" the TRXLA2 will accept remote control commands via ZaxNet – if this is set to "OFF" the TRXLA2 will not receive ZaxNet commands.

IFB Jam Threshold

IFB JAM THRESH
1000 MS (DEFAULT)

This menu sets how much the time code has to jump before a new file is forcibly created so that file will have an updated time code stamp.

IMPORTANT: If a new file is created, while a take is in progress, about a half of second of the audio will be lost.

QRX Software Update

PRESS ↑ TO SEND
QRX PROG FILE

This menu is used to update the software on a QRX Receiver.

To Update the QRX Software:

1. With a computer copy the QRX software onto a formatted micro SD card.
2. Place the card in the transmitter
3. Power up the transmitter.
4. Advance to this menu.
5. Press the INC key.
6. The transmitter will begin to transmit the software to a QRX Receiver that is set to receive the software. The transmitter will continually resend the program until you manually stop it.

Phase Invert Channel 2

PHASE INVER CH2
OFF

This will allow you to invert the phase of channel 2 (Right) audio to correct for a phasing issue on a stereo transmitter.

This would only be used if you had a TRXLA2 and you are using stereo mode.

Transmitter Disable - Record only mode

TX DISABLE:
NORMAL TX MODE

- **Record Only Mode** – This will set the TRXLA2 to act as a standalone recorder and will not transmit any RF audio on the UHF band and will conserve battery power.
- **Normal TX Mode** – This will allow the TRXLA2 to both transmit RF audio and record on its internal SD card.

Low Battery Stop Set

LOW BATT STOP:
NEVER STOP

LOW BATT STOP:
5 MINUTES

This menu allows you to set the amount of time, after a low battery warning occurs, the on-board recorder will close the current file and stop recording.

This is to prevent possible file corruption if the unit powers off and on due to a dead battery.

- **NEVER STOP** - The recorder will not stop recording unless you stop it or the battery dies.
- **Any interval from 1 to 99 minutes** - once the battery indicator starts blink a low battery warning the transmitter will continue to record for the time set in the menu - then it will close the file and stop recording.

Automatic Record After Bootup

RECORD ON BOOTUP
ON

This menu will let you set if the TRXLA2 will automatically go into record after the unit boots up.

- **ON** - The transmitter will automatically start to record after it boots up.
- **OFF** - The transmitter will wait for a ZaxNet command or a manual record trigger to start recording.

Transmitter Name Set

NAME: SN1234
↑

This menu allows you to change the name of the transmitter from the default name - which is the unit's serial number.

The name entered into the unit becomes part of the name of the audio files generated by the unit and is also included in the metadata of the BWF file. Naming the unit aids in identifying the files from several different wireless.

The maximum Name length is 8 characters. You can select any letter or number and can even use spaces.

To set/change the transmitter name:

1. Press the INC or DEC key to change the character in the current position.
2. Press the MENU key to proceed to the next character.
3. When finished, press and hold the MENU key set the name and leave this page or you can cycle the power.

Encryption Menu Hide

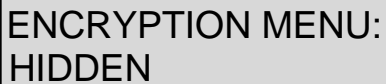

ENCRYPTION MENU:
HIDDEN

This allows you to hide the Encryption Menu.

- **HIDDEN** the encryption menu doesn't appear when you cycle through the menu settings.
- **ON** the encryption menu will appear.

Encryption Code Set



ID1:000 ID0:000
↑

If you set an encryption code the transmitted audio will be encrypted and can only be listened to if the receiver has the matching encryption code entered. When receiving an audio signal and the codes do not match, all that will be heard is white-noise or silence. So if using encryption make sure the matching receiver has the same code.

These two sets of numbers are formed into a single six-digit encryption code which provides a total of 16,777,216 possible combinations.

To adjust the encryption code

1. Momentarily press the MENU key to advance to the next character.
2. To change the designated character, press the INC or DEC key.
3. To exit this page, press and hold the MENU key for 1 second.

NOTE: Both of these codes should always be set to **000** for normal un-encrypted operation.

Media

While any size card will work we recommend using a 4GB Micro SD card. We also recommend that you buy a brand name card such as Transcend, SanDisk. You should always buy your cards from a reputable dealer because counterfeit cards exist and can cause recording issues.

We also recommend that you test your card before taking them out into the field.

Here is a testing procedure to determine if the card will function correctly:

1. Format the card in the transmitter.
2. Power cycle the unit.
3. Record at least 20 minutes of audio to a card with no time code source.
4. Look at the Main Screen it should still be recording in segment #1.

Media Capacity

The TRX can use Micro SD cards, ranging in size from 128 MB to 16 GB. While any size card will work we recommend using 4GB cards.

Available recording times are as follows:

Media Size	Available Recording Time
128 MB	45 minutes
256 MB	1.5 hours
512 MB	3 hours
1 GB	6 hours
2 GB	12 hours
4 GB	24 hours
8 GB	48 hours
16 GB	96 hours

IMPORTANT: The transmitter will **NOT** record onto the card if:

- The card was not present when the unit was powered up
- If the card was removed while the power was 'ON'
- If the LOW BATTERY is being displayed.

NOTE: Regardless of the size of the card the TRX will only be able to record 254 segments on the card.

Recording Format

The media card is formatted using a FAT32 file system. While recording, the unit places all recorded audio in a single file on the media.

The files generated by the recorder (.zax format) can only be recognized by Zaxcom's ZaxConvert program. Using ZaxConvert will transfer the file to a Broadcast Wave or MP3 file. This utility is available to anyone for free from the Zaxcom website <http://www.zaxcom.com/software-updates>

Firmware

Each unit is shipped with the latest firmware version installed. As newer firmware becomes available, it can be downloaded from the Zaxcom website:

<http://www.zaxcom.com/software-updates>

Newer version of Beta software may be found on the Zaxcom Forums:

<http://www.zaxcom.com/forum>

Each time a unit is powered up, the firmware version number is displayed briefly on the LCD screen. Pressing the DEC key during the boot up will slow down the screen to allow easier viewing of the information.

Updating TRX Firmware

1. Download the firmware from the Zaxcom website and load it onto a formatted card.
2. Insert the card into the TRX transmitter.
3. Simultaneously hold down the INC and DEC keys while powering up the unit.
4. The screen will display "BURN ROM" with the version of firmware you are loading.
5. From power up to "DONE" will take about 30 seconds.
6. Upon completion, cycle the power to run on the new version.

WARNING: Do not power down the unit during the upgrade process. Before upgrading the software be sure to insert a fresh set of batteries. If the unit should lose power during the upgrade, it will need to be sent back to Zaxcom for repair.

Updating an ERX with your TRX Transmitter

1. Format a card in your TRX.
2. With a computer perform the following:
 - Delete the "DELETE.ME" file on the card
 - Download the ERX firmware "ERX-XXX.bin" from the Zaxcom website and load it onto a card formatted by the TRX.
3. Insert the card into the TRX.
4. Check that the ERX is set to the same ZaxNet frequency that the TRX is set to. Check that the GROUP ID is set the same in both the TRX and ERX. And make sure encryption is shut off.
5. Boot up the ERX while holding the Menu key to get to the ERX EXTENDED menu.
6. On the ERX Press menu 5 times till you see the software update page.
7. Press the INC key on the ERX 5 times till you see WAITING FOR PROGRAM.
8. Power up the TRX.
9. If your TRX is running software version 8.0 or higher in the EXTENDED Menu shut off RX to TX mode.
10. Go to the LOCK page and press down 6 times quickly to get to the FACTORY Menu.
11. Press the MENU key once to get to the IFBMODE page.
12. Press the INC key 3 times till you see IFBMODE 3 TX.
13. Press MENU 3 times until you see SEND ERX PROG FILE.
14. Press the INC key to trigger the update process.
15. The ERX should indicate its progress after a few seconds.
16. When the ERX has been updated the screen will display "SUCCESS".

Inputting Audio

The TRXLA2 use an unbalanced microphone input via a 3-pin micro-LEMO connector. You can use an unbalanced dynamic microphone or a powered lavalier.

You can use a line-level input though an inline pad is required.

Recommended Microphones

Zaxcom recommends the following microphones for use with the TRXLA2:
Countryman EMW, B3, B6, Sanken COS-11D, DPA 4063

Wiring Diagrams

The following 3-pin micro-LEMO connectors mate with the microphone connector:

- FGB.00.303.CLAD.22 – has a latch with a pull release (recommended for RFI prevention).
- FVB.00.303.NLA – has a latch with a twist release.

IMPORTANT: It is recommended that the ground gets attached to the shell of the LEMO connector.

Two Wire Microphone Configuration

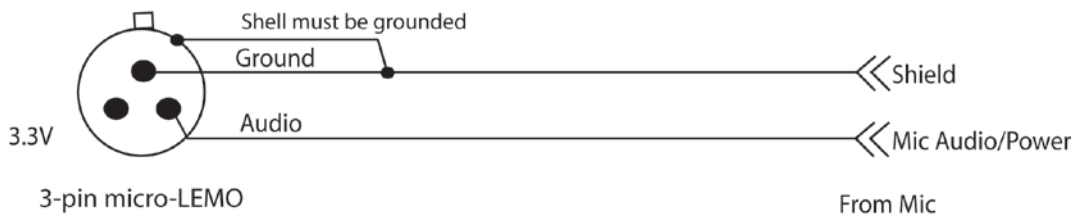

Three Wire Microphone Configuration

Please contact your microphone manufacturer.

Stereo Microphone Configuration

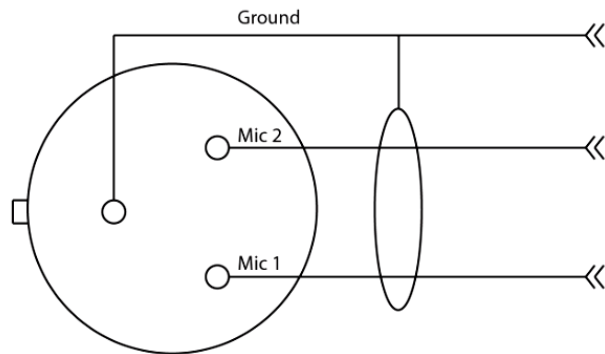

Balanced Line Level and time code Input

Mono line-level and/or timecode input

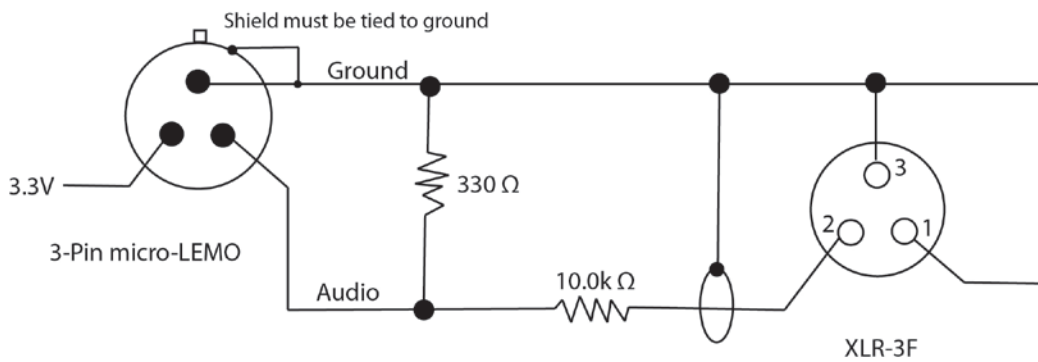

Stereo Line Level

Stereo line-level input with pads

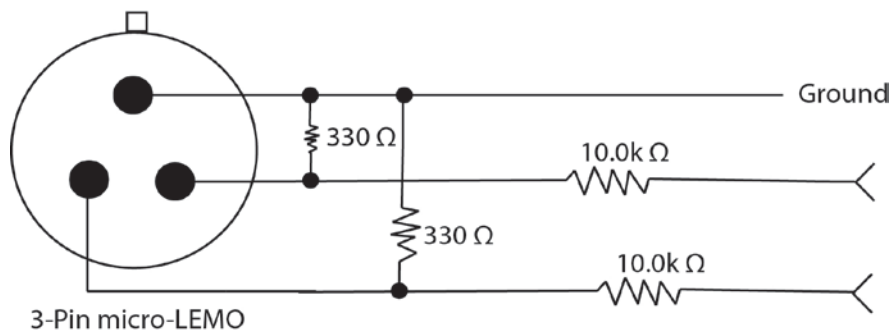

Operating Frequencies

ZaxNet Remote Control and Time Code

2.403 to 2.475 GHz

UHF Audio

TRXLA2.5

512.0 MHz to 614.0 MHz (Blocks 20 through 23)

TRXLA2.6

596.0 MHz to 698.0 MHz (Blocks 23 through 26)

SMA/SSMA ANTENNA CUTTING CHART

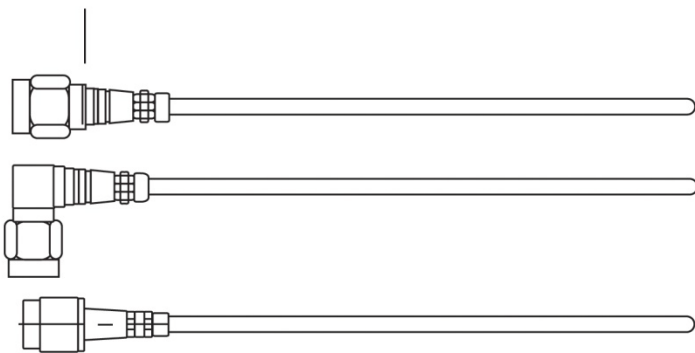
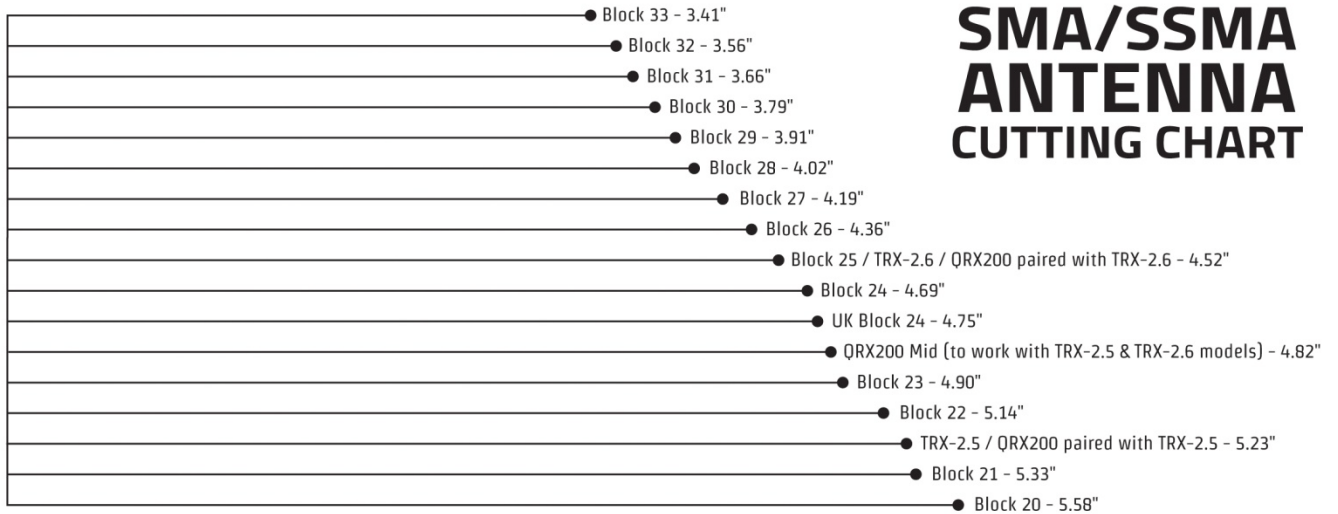

ZAXCOM

www.zaxcom.com



Specifications

Transmitter

TRX-LA2 Power Output: 25 / 50 / 125 mW – Software Selectable
RF Modulation: Proprietary Digital Method
TRXLA2.5 RF Frequency Range: 512 - 614 MHz
TRXLA2.6 RF Frequency Range: 596 - 698 MHz
RF Frequency Step: 100 KHz
RF Bandwidth: 200 KHz
Channel Separation: 500 KHz (700 KHz recommended)
Antenna Connector: 50 Ω SSMA Female
Emission Designator: 180 KV2E
FCC Part: 75.861

Transmitter Audio

Dynamic Range: 106 dB
Distortion: 0.001%
Frequency Response: Mode 0: 20 Hz to 16 kHz / T & M Mode 0.2 Hz to 16 kHz
High Pass Filter: Off or 30 to 220 Hz, Steps: 10 (6 dB Per Octave)
System Group Delay: 3.5 ms
Mic Power: 3.3 VDC
Mic Connector: 3-Pin Micro LEMO
Input Range: -60 to -30 dBu
Mic Impedance: 4.7 k Ω
ADC Bit-Depth: 24 Bits

Time code Reader / Generator

Clock Accuracy: 1.54 PPM (1 Frame Out in 6 Hours)
Time code Type: SMPTE
Time code Frame-Rates: 23.98, 24, 25, 29.97NDF, 29.97DF, 30NDF, 30DF

Internal Recording

Media: MicroSD Card (Flash Memory)
File Format: .ZAX
Recording Time: 96 Hours (16 GB Card)

2.4 GHz ZaxNet Receiver

RF Frequency Range: 2.403 to 2.475 GHz
RF Modulation: Digital Spread Spectrum
RF Frequency Step: 0.001 GHz (1 MHz)
RF Bandwidth: 1 MHz
Channel Separation: 2 MHz
Sensitivity: -96 dBm

Physical

Weight: 3.6 oz with Battery
Dimensions (H x W x D): 3.0" x 2.4" x .65"
Display: Graphic LCD

Battery Life

TRX-LA2 Battery Life: Up to 7 Hours with 2 Lithium AA at 125mW

All Specifications are subject to change without notice.

Product Support

Register your product with Zaxcom:	http://zaxcom.com/support/product-registration/
Download the latest Firmware from:	http://zaxcom.com/support/updates/
Download the latest User Manuals from:	http://zaxcom.com/support/updates/
Submit Technical Questions at:	http://www.zaxcom.com/submit-a-technical-question
Submit information for Repair Services at:	http://www.zaxcom.com/support/repairs
Join the Zaxcom User Forum at:	http://www.zaxcom.com/forum/forum.php
Join the Zaxcom Face Book User Group at:	https://www.facebook.com/groups/682199065139938/

Consumer Alert

Most users do not need a license to operate a wireless microphone system. Nevertheless, operating a microphone system without a license is subject to certain restrictions:

- the system may not cause harmful interference,
- it must operate at a low power level (not in excess of 50 milliwatts),
- it has no protection from interference received from any other device.

Purchasers should also be aware that the FCC is currently evaluating the use of wireless microphone systems, and these rules are subject to change. For more information, call the FCC at 1-888-CALL-FCC (TTY: 1-888-TELL-FCC) or visit the FCC's wireless microphone website at:

www.fcc.gov/cgb/wirelessmicrophones. To operate wireless microphone systems transmitting with greater than 50mW of radiated power, you must qualify as a Part 74 user and be licensed.

This alert does **NOT** apply to Part 74 users

Zaxcom Digital Wireless is protected under patent #'s: 7,711,443 & 7,929,902

Zaxcom Warranty Policy and Limitations

Zaxcom Inc. values your business and always attempts to provide you with the very best service.

No limited warranty is provided by Zaxcom unless your TRX ("Product") was purchased from an authorized distributor or authorized reseller. Distributors may sell Product to resellers who then sell Product to end users. Please see below for warranty information or obtaining service. No warranty service is provided unless the Product is returned to Zaxcom Inc. or a Zaxcom dealer in the region where the Product was first shipped by Zaxcom.

Warranty Policy

The Product carries a Standard Warranty Period of one (1) year.

NOTE: The warranty period commences from the date of delivery from the Zaxcom dealer or reseller to the end user.

There are no warranties which extend beyond the face of the Zaxcom limited warranty. Zaxcom disclaims all other warranties, express or implied, regarding the Product, including any implied warranties of merchantability, fitness for a particular purpose or non-infringement. In the United States, some laws do not allow the exclusion of the implied warranties.

Troubleshooting & Repair Services

No Product should be returned to Zaxcom without first going through some basic troubleshooting steps with the dealer you purchased your gear from.

To return a product for repair service, go to the Zaxcom Repair Services page <http://www.zaxcom.com/repairs> and fill in your information; there is no need to call the factory for an RMA. Then send your item(s) securely packed (in the original packaging or a suitable substitute) to the address that was returned on the Repair Services page. Insure the package, as we cannot be held responsible for what the shipper does.

Zaxcom will return the warranty repaired item(s) via two-day delivery within the United States at their discretion. If overnight service is required, a FedEx or UPS account number must be provided to Zaxcom to cover the shipping charges.

*Please note a great resource to troubleshoot your gear is the Zaxcom Forum: <http://www.zaxcom.com/forum>.

Warranty Limitations

Zaxcom's limited warranty provides that, subject to the following limitations, each Product will be free from defects in material and workmanship and will conform to Zaxcom's specification for the particular Product.

Limitation of Remedies

Your exclusive remedy for any defective Product is limited to the repair or replacement of the defective Product.

Zaxcom may elect which remedy or combination of remedies to provide in its sole discretion. Zaxcom shall have a reasonable time after determining that a defective Product exists to repair or replace a defective Product. Zaxcom's replacement Product under its limited warranty will be manufactured from new and serviceable used parts. Zaxcom's warranty applies to repaired or replaced Product for the balance of the applicable period of the original warranty or thirty days from the date of shipment of a repaired or replaced Product, whichever is longer.

Limitation of Damages

Zaxcom's entire liability for any defective Product shall, in no event, exceed the purchase price for the defective Product. This limitation applies even if Zaxcom cannot or does not repair or replace any defective Product and your exclusive remedy fails of its essential purpose.

No Consequential or Other Damages

Zaxcom has no liability for general, consequential, incidental or special damages. These include loss of recorded data, the cost of recovery of lost data, lost profits and the cost of the installation or removal of any Product, the installation of replacement Product, and any inspection, testing or redesign caused by any defect or by the repair or replacement of Product arising from a defect in any Product.

In the United States, some states do not allow exclusion or limitation of incidental or consequential damages, so the limitations above may not apply to you. This warranty gives you specific legal rights and you may also have other rights, which vary from state to state.

Your Use of the Product

Zaxcom will have no liability for any Product returned if Zaxcom determines that:

- The Product was stolen.
- The asserted defect:
 - Is not present,
 - Cannot reasonably be fixed because of damage occurring when the Product is in the possession of someone other than Zaxcom, or
 - Is attributable to misuse, improper installation, alteration, including removing or obliterating labels and opening or removing external covers (unless authorized to do so by Zaxcom or an authorized Service Center), accident or mishandling while in the possession of someone other than Zaxcom.
- The Product was not sold to you as new.

Additional Limitations on Warranty

Zaxcom's warranty does not cover Product, which has been received improperly packaged, altered or physically abused.